

Exposed grid,
demountable

OWAlifetime collection

OWA

System S 3a | exposed grid, demountable

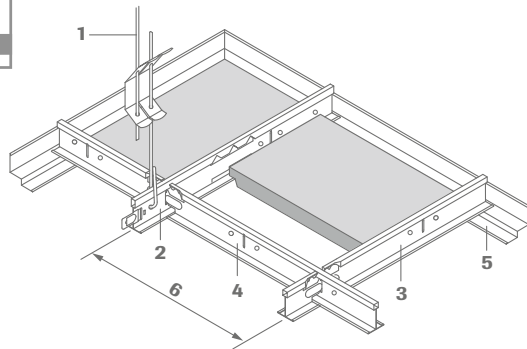

- 1 Hanger no. 12/.../...
- 2 Main tee no. 45, slots at 100 mm or 156.25 mm
- 3 Cross tee no. 46
- 4 Cross tee no. 47
- 5 Shadow wall angle no. 50/15 for edge 6
Shadow wall angle no. 50/14 for edge 7
- 6 Module distance
- 7 Contura block no. 42/24 for edge 6
Contura block no. 42/7 for edge 7

Section:

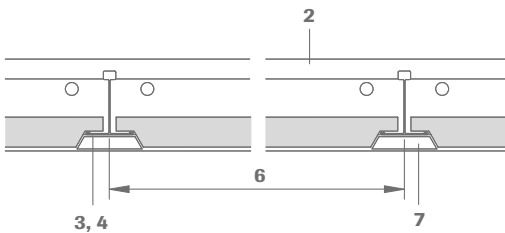

Cross-section:

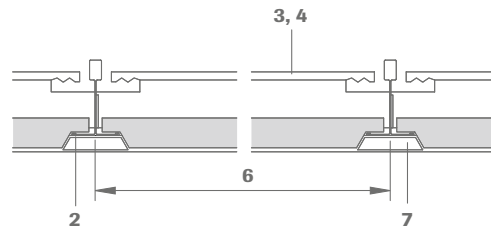

Section dimensions:

No. 45

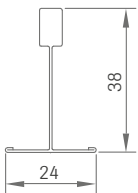

No. 46 and 47

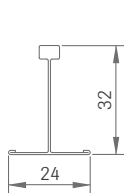

Installation:

The cross tees have connection tabs on each end, 2 cross tee sections are inserted into each slot in the main tee section but care must be taken to insert the tabs correctly so that the tees are in correct alignment. The ends of the main tee sections have offset connectors which will lock when engaged.

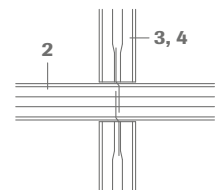

Technical data | mineral tiles

Dimensions/Designs

For possible dimensions and designs, please refer to the [OWAlifetime collection price list 9001 e](#).

Edge details



Thickness

Approx. 15 mm and 20 mm

Approx. 14 mm (design Brillianto A)

Resistance to fire

A2-s1,d0 in accordance with EN 13501-1

Reaction to fire

[See OWA brochure 9501 eu e](#)

Metal suspensions

All metal parts galvanised or coated white; for further details and colours see [OWAlifetime collection price list 9001 e](#).

Suspension depth

75 - 100 mm (depending on the existing structural ceiling) for ease of panel removal 120 mm is recommended

Wall perimeter:

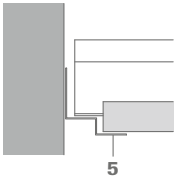

For more information about installation, see [OWA-Installation Guide 9801 e](#).

Installation examples:

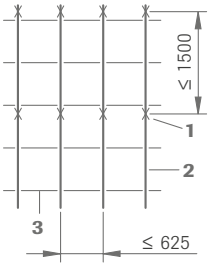

Module 625 x 625 mm

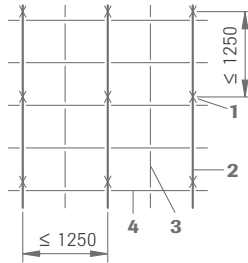

Module 625 x 625 mm

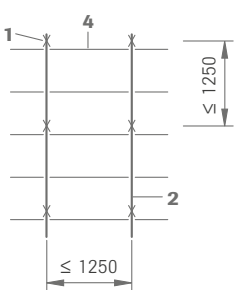

Module 1250 x 625 mm

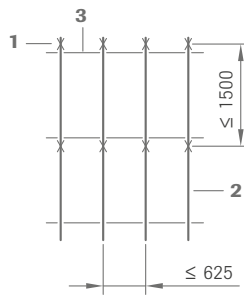

Module 1250 x 625 mm

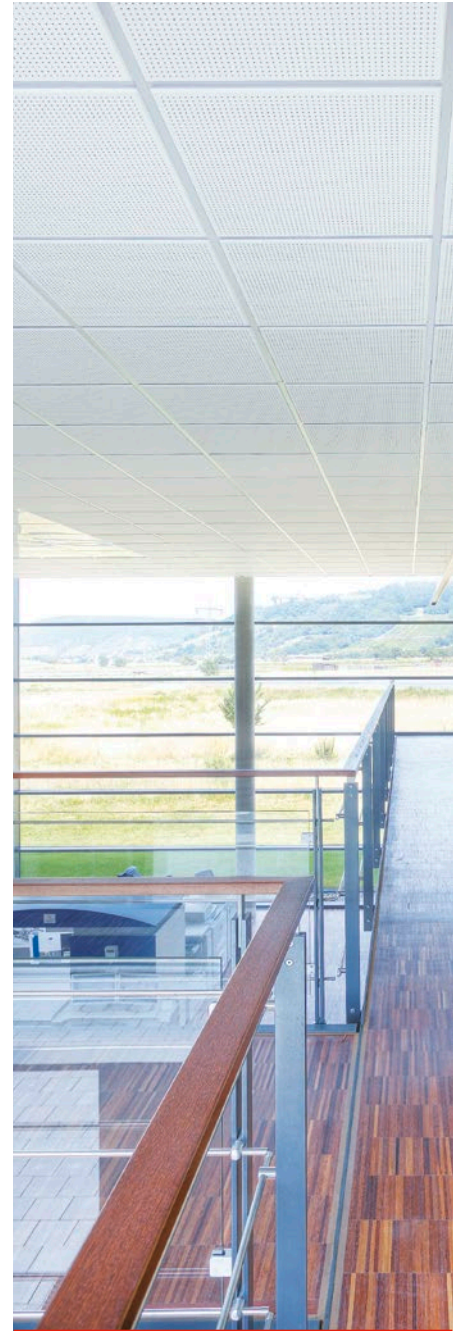

Light fixtures:

OWA can supply compatible light fixtures for this system.

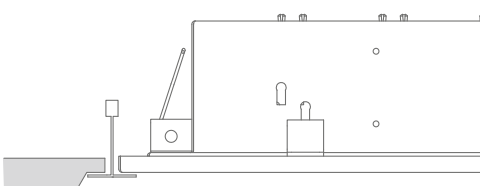

For details of performance, installation and fire resistance please see [OWA-brochure 9630 e](#) and [OWA-Installation Guide 9801 e](#).

Material requirements per m² (approximations):

Module sizes in mm

No.	Description	600 x 600	610 x 610	625 x 625	625 x 625*	1200 x 600	1220 x 610	1250 x 625
12/.../...	Hanger	0,7 pce	0,7 pce	0,7 pce	1,1 pce	0,7 pce	0,7 pce	0,7 pce
45	Main tee	0,83 m	0,82 m	0,8 m	1,6 m	0,83 m	0,82 m	0,8 m
46	Cross tee	0,83 m	0,82 m	0,8 m	1,6 m	-	-	-
47	Cross tee	1,66 m	1,64 m	1,6 m	-	1,66 m	1,64 m	1,6 m
50/15 resp. 50/14	Shadow wall angle	depending on room size and shape						
42/24 resp. 42/7	Contura block	1.6 pcs per linear metre of wall angle						

* Installed with main tee centres (\leq 625 mm)

Weight per m²:

	600 x 600	610 x 610	625 x 625	625 x 625*	1200 x 600	1220 x 610	1250 x 625
Suspension system approx.	1,25 kg/m ²	1,23 kg/m ²	1,20 kg/m ²	1,22 kg/m ²	0,94 kg/m ²	0,92 kg/m ²	0,88 kg/m ²
Tile 15 mm. approx.	4,5 kg/m ²	4,5 kg/m ²	4,5 kg/m ²	4,5 kg/m ²	4,5 kg/m ²	4,5 kg/m ²	4,5 kg/m ²

For special situations, for example addition of wool overlays, light fixtures, cold roofs, high humidity and open areas etc., see [OWA-Installation Guide 9801 e](#). For fire resistant ceilings, the distances between main tee profiles and suspension points must comply with the relevant test reports (see [OWA brochure 9501 eu e](#)).

System description:

Exposed grid, demountable OWAconstruct System S 3a

Quality requirements for mineral tiles:

OWAacoustic mineral tiles firmly bound with a primer coat on both sides. The tile is free from asbestos. No formaldehyde is added in the manufacturing process of the mineral tiles. The mineral wool used for the manufacture of the tile is bio-soluble. The criteria for non-classification as a carcinogenic substance in accordance with the Chemicals Prohibition Ordinance (Section 1 Appendix, Paragraph 23 biopersistent fibres) are met and guaranteed by the 'RAL seal of approval for mineral wool'. Verification of fitness for use according to EU CPR: CE marking and Declaration of Performance (DoP).

Mineral tiles accordance with EN 13964 and DIN 18177:

Air permeability class PM 1
Formaldehyde class FH 1
Emission of VOC TVOC 1

Installation should be carried out in accordance with the information contained in system leaflet S 3a and [OWA-Installation Guide 9801 e](#). All components are CE labelled.

Component list:

OWAconstruct hanger no. 12/.../...
OWAconstruct main tee no. 45
OWAconstruct cross tee no. 46, no. 47, no. 48
OWAconstruct wall angle no. 50/15 for edge 6
OWAconstruct wall angle no. 50/14 for edge 7
OWAconstruct Contura block no. 42/24 for edge 6
OWAconstruct Contura block no. 42/7 for edge 7



Certified Management Systems

Product warranties

The information provided in this leaflet is based on the standards and data available at the time of publication. Any performance, warranties or guarantees provided, expressed or implied, are subject to the exclusive use of OWA components and the installation of those components in accordance with our recommendations. Failure to adhere to these conditions will result in the invalidation of any performance claims, warranties or guarantees and rejection of any liability. OWA reserves the right to make any technical improvements to the products, systems or services without prior notice. **All goods and services are supplied in accordance with our current Terms and Conditions of Sale.** Errors excepted!



The information in this brochure is up-to-date at the time of publication. Subject to alterations. Please contact our competence team OWAconsult for specific advice. Our experts will be happy to answer your questions under the following contact details: tel: +49 9373 201-444 or e-mail: info@owaconsult.de

Odenwald Faserplattenwerk GmbH

Dr.-F.-A.-Freundt-Straße 3 | 63916 Amorbach | Germany
tel +49 9373 201-0 | info@owa.de
www.owa-ceilings.com