



Hook-in system with Z profile,
demountable

OWAtecta – metal ceilings

OWA

System S 39 | Hook-in system with Z profile, demountable



Isometrie:

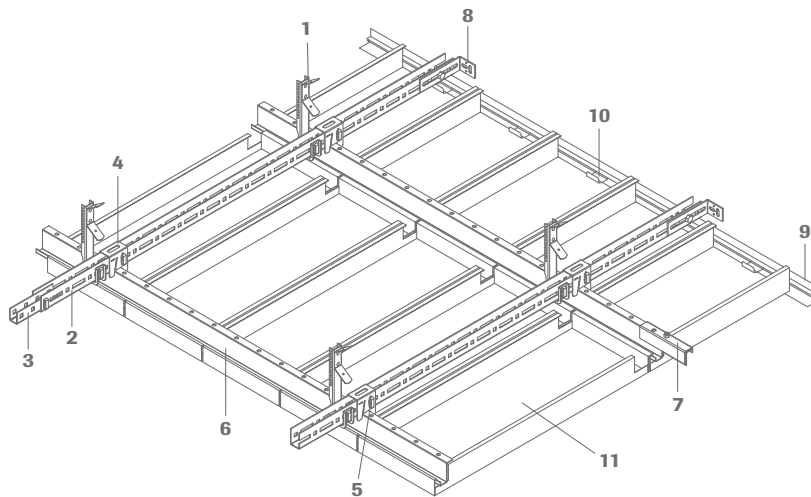

- 1 Hanger no. 1782E
- 2 Main tee no. 70E
- 3 Connector no. 77E
- 4 Hanger no. 12E02
- 5 Safety clip no. 66E
- 6 Z profile no. 90E01
- 7 Connector no. 25E
- 8 Wall anchor no. 75E
- 9 F wall angle no. 50F
- 10 Wall spring clip no. 5220
- 11 Metal plank

Section:

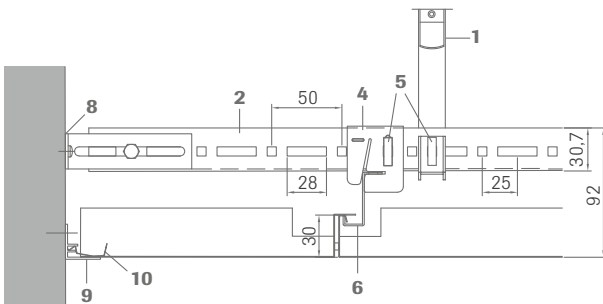

Technical data

Dimensions	Widths: 250 - 625 mm Lengths: 600 - 3000 mm
Material	Galvanised sheet steel, perforated version - glued with black acoustic fleece
Colour	White (similar RAL 9003)
Reaction to fire	A2-s2,d0 in accordance with EN 13501-1 depending on the version
Edges	Long edge: 10, short edge: 11
Thickness	Approx. 0.5 - 0.7 mm (depending on the version)
Metal suspension	All metal parts galvanised or additionally coated white
Minimum suspension depth	Approx. 200 mm

Perforations:

$\alpha_w = 0.05$ | NRC = 0.05

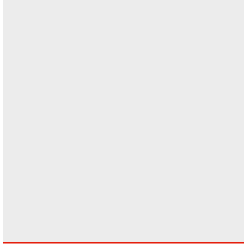

L0 un-perforated

$\alpha_w = 0.55$ | NRC = 0.55

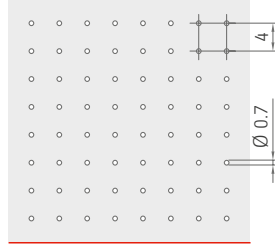

Rg0702
Ø 0.7 mm
2 % open area

$\alpha_w = 0.70$ | NRC = 0.70

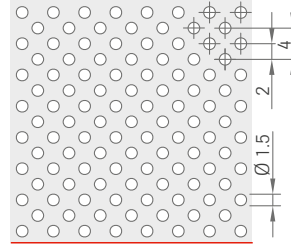

Rd1522
Ø 1.5 mm
22 % open area

$\alpha_w = 0.8$ | NRC = 0.75

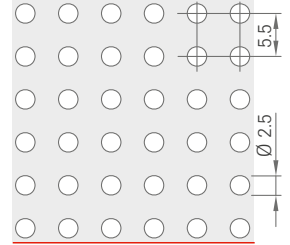

Rg2516
Ø 2.5 mm
16 % open area

Other perforations can be found in brochure no. 9391 e.

Wall perimeter:

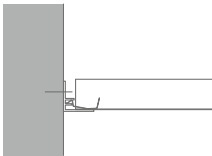

L wall angle **no. 50F**
aluminium, visible side white
+ wall spring clip no. 5220

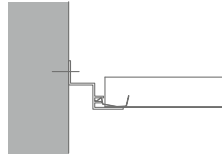

F shadow wall angle **no. 5620F**
aluminium, visible side white
+ wall spring clip no. 5220

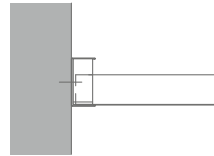

C wall angle **no. 57**
steel, visible side white
+ wall spring clip no. 5210

For more perimeter options please consult OWAtecta Installation Guide no. 9303 e.

Installation example:

module 1250 x 400 mm

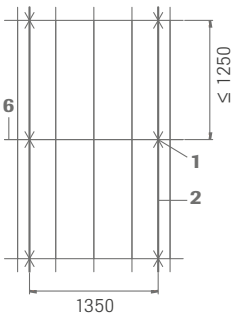

Tile length ≤	Main tee distance T ≤	Hanger distance A ≤
600 mm	1900 mm	1250 mm
625 mm	1875 mm	1250 mm
1250 mm	1350 mm	1250 mm
1500 mm	1200 mm	1500 mm
2000 mm	1050 mm	2000 mm
2500 mm	850 mm	2000 mm

The hangers should always be placed at the crossing points of the supporting profile and the Z-profile and should not be mounted further than 100 mm away from them. The maximum distance of the hangers is thus dependent on the length of the plates, but must not exceed a distance of 2000 mm.

See OWAtecta Installation Guide no. 9303 e for further information.

System S 39 Mesh | Expanded metal hook-in system with Z profile



Isometrie:

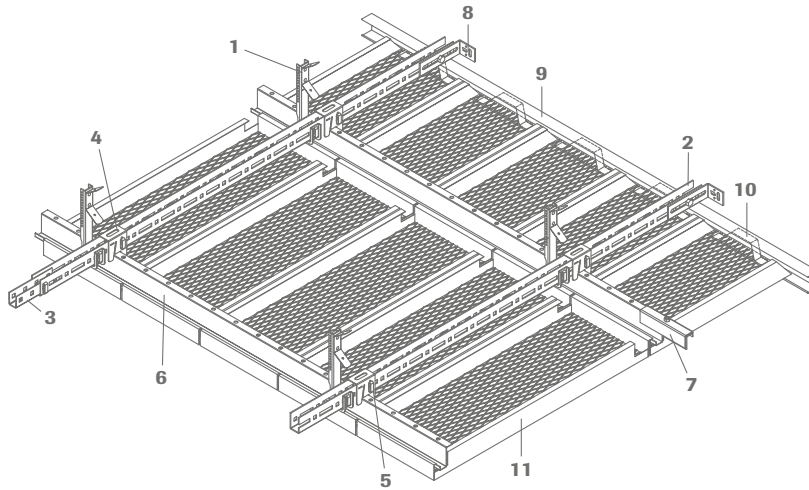

- 1 Hanger no. 1782E
- 2 Main tee no. 70E
- 3 Connector no. 77E
- 4 Hanger no. 12E02
- 5 Safety clip no. 66E
- 6 Z profile no. 90E01
- 7 Connector no. 25E
- 8 Wall anchor no. 75E
- 9 C wall profile no. 57
- 10 Wall spring clip no. 5210
- 11 Metal plank

Sections:

Type D

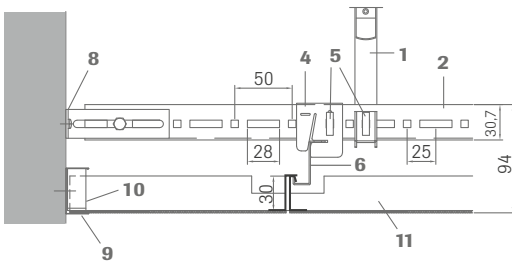

Type E

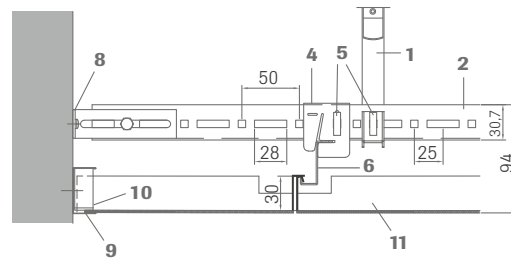

Technical data

Dimensions	Widths: 250 - 625 mm Lengths: 600 - 2500 mm
Material	Steel, galvanised
Colour	White (similar RAL 9003)
Reaction to fire	A2-s1,d0 in accordance with EN 13501-1
Edges	Long edge: 10, short edge: 11
Panel shapes	Type D: with L-shaped frame Type E: with straight frame
Mesh patterns	R 16 x 8 R 30 x 10 R 42 x 13 R 60 x 20
Mesh shape	Diamant

Wall perimeter:

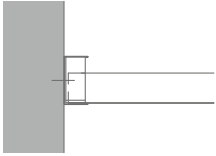

C wall angle **no. 57**
steel, visible side white
+ wall spring clip no. 5210

For more perimeter options please consult OWAteca Installation Guide no. 9303 e.

Installation example:

module 1250 x 400 mm

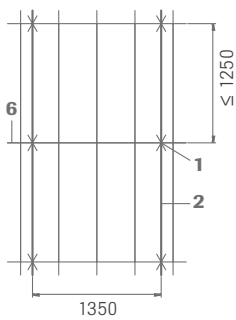

Tile length \leq	Main tee distance $T \leq$	Hanger distance $A \leq$
600 mm	1900 mm	1250 mm
625 mm	1875 mm	1250 mm
1250 mm	1350 mm	1250 mm
1500 mm	1200 mm	1500 mm
2000 mm	1050 mm	2000 mm
2500 mm	850 mm	2000 mm

The hangers should always be placed at the crossing points of the supporting profile and the Z-profile and should not be mounted further than 100 mm away from them. The maximum distance of the hangers is thus dependent on the length of the plates, but must not exceed a distance of 2000 mm.

See OWAteca Installation Guide no. 9303 e for further information.

System S 39 Mesh | Expanded metal hook-in system with Z profile

Panel shapes:

Type D

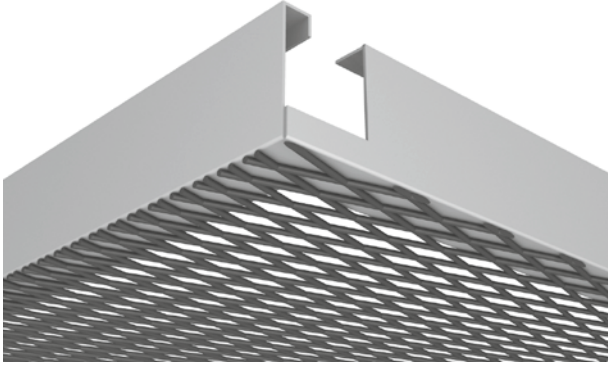

With L-shaped frame, made from a long panel with cut-out, welded onto the expanded metal plate from behind.

Type E

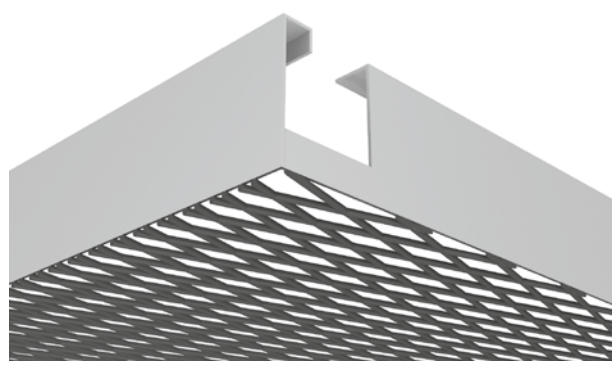

With frame welded to the expanded metal tile at the edges. The expanded metal tile and frame has no bended edges.

Standard mesh patterns:

Diamond shape

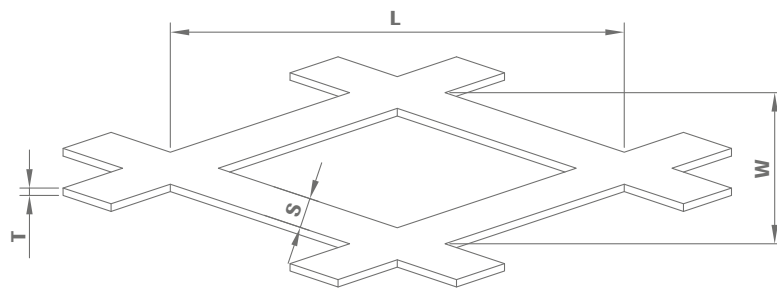

L = Length
W = Width
S = Strand width
T = Thickness

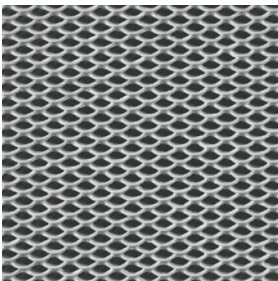

Mesh R 16 x 8
75 % open area
Strand width 1,0 mm
Thickness 1,0 mm

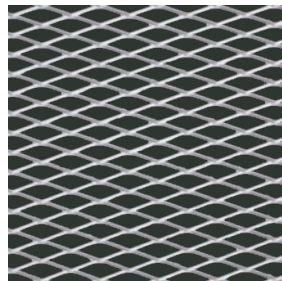

Mesh R 30 x 10
60 % open area
Strand width 2,0 mm
Thickness 1,0 mm

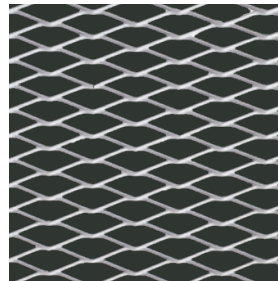

Mesh R 42 x 13
69 % open area
Strand width 2,0 mm
Thickness 1,0 mm

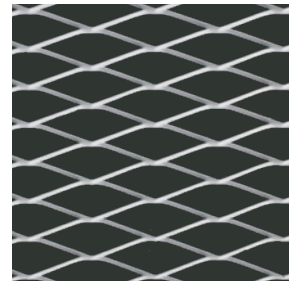

Mesh R 60 x 20
70 % open area
Strand width 3,0 mm
Thickness 1,0 mm

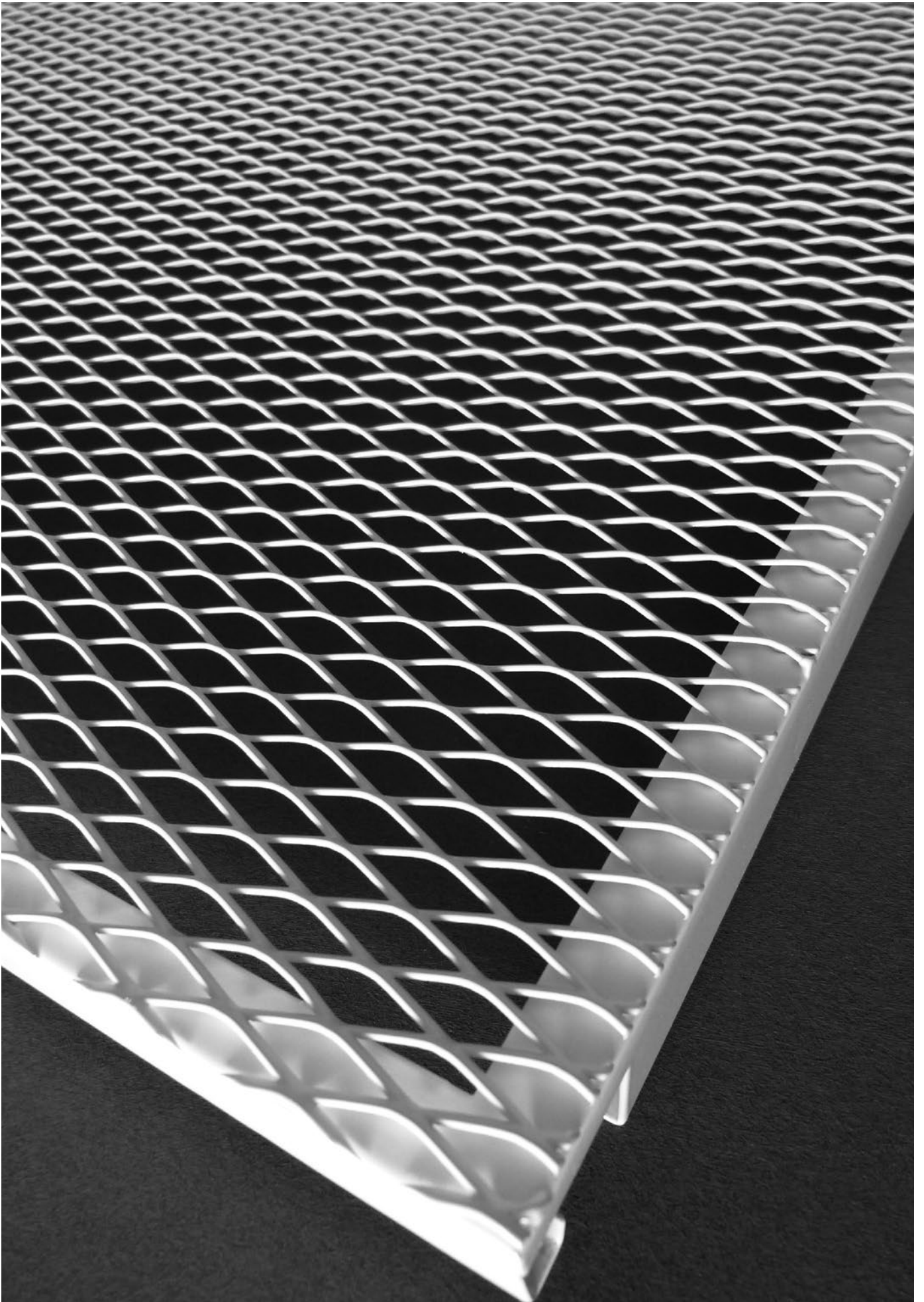

Material requirements per m² (approximations):

module sizes in mm

No.	Description	625 x 625	1250 x 300	1500 x 300	2000 x 300	2500 x 300
1782E	Hanger	0.5 piece	0.6 piece	0.6 piece	0.5 piece	1.2 piece
70E	Main tee	0.6 m	0.8 m	0.83 m	1 m	1.2 m
77E	Connector	0.1 piece	0.21 piece	0.22 piece	0.27 piece	0.32 piece
12E02	Hanger	0.9 piece	0.6 piece	0.6 piece	0.5 piece	0.5 piece
66E	Safety clip	1.3 piece	1.2 piece	1.2 piece	1 piece	1.68 piece
90E01	Z profile	1.6 m	0.83 m	0.67 m	0.5 m	0.4 m
25E	Z profile connector	0.4 piece	0.2 piece	0.16 piece	0.15 piece	0.1 piece
75E	Wall anchor	Dependent on room size and shape				
50F	L wall angle	Dependent on room size and shape				
5220	Wall spring clip	Dependent on room size and shape				

Weight per m²:

	625 x 625	1250 x 300	1500 x 300	2000 x 300	2500 x 300
Suspension system approx.	1.79 kg/m ²	1.41 kg/m ²	1.32 kg/m ²	1.33 kg/m ²	1.51 kg/m ²
Unperforated tiles approx.	4.71 kg/m ²	6.35 kg/m ²	6.62 kg/m ²	7.62 kg/m ²	7.93 kg/m ²

Blue Angel

These products meet the Ecolabel requirements for „Low-emission thermal insulation and ceiling products designed for use in buildings, RAL UZ 132“

(October 2010 edition).

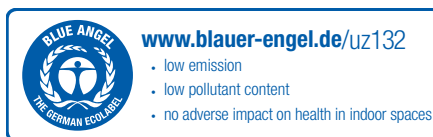

In clinical and hygienic-sensitive areas:
surface un-perforated (L0)



VOC emissions OWAtecta metal ceiling tiles

Appropriate for use in indoor spaces in accordance with the AgBB and the „approval principles regarding health assessments of construction products in indoor spaces“.

Please refer to OWA-brochure no. 9398 e and OWAtecta Installation Guide no. 9303 e for recommendations regarding classification and versions.

System description:

visible, demountable OWAconstruct system S 39 (suspension system)

Quality statement:

OWAtecta clip-in tiles are manufactured from galvanized sheet steel, available as un-perforated or perforated with glued-in acoustic fleece version, visible face white (similar RAL 9003). Regarding material characteristics, size and colour accuracy we follow our quality guidelines, which are on par with TAIMguidelines (Association of Industrial Metal Ceiling Manufactureres) as well as EN 13964.

Special features can be found in the OWAtecta Installation Guide no. 9303 e.

Product warranties

The information provided in this leaflet is based on the standards and data available at the time of publication. Any performance, warranties or guarantees provided, expressed or implied, are subject to the exclusive use of OWA components and the installation of those components in accordance with our recommendations. Failure to adhere to these conditions will result in the invalidation of any performance claims, warranties or guarantees and rejection of any liability. OWA reserves the right to make any technical improvements to the products, systems or services without prior notice. **All goods and services are supplied in accordance with our current Terms and Conditions of Sale.** Errors excepted!

The information in this brochure is up-to-date at the time of publication. Errors and mistakes excepted. Please contact our competence team OWAconsult for specific advice. Our experts will be happy to answer your questions under the following contact details: tel: +49 9373 201-444 or e-mail: info@owaconsult.de

OWA

Odenwald Faserplattenwerk GmbH

Dr.-F.-A.-Freundt-Straße 3 | 63916 Amorbach | Germany
tel +49 9373 201-0 | info@owa.de
www.owa-ceilings.com